

Article number: 20907642

Description: E+G Ball point screw
GN 605-M8-30-VR

Measures

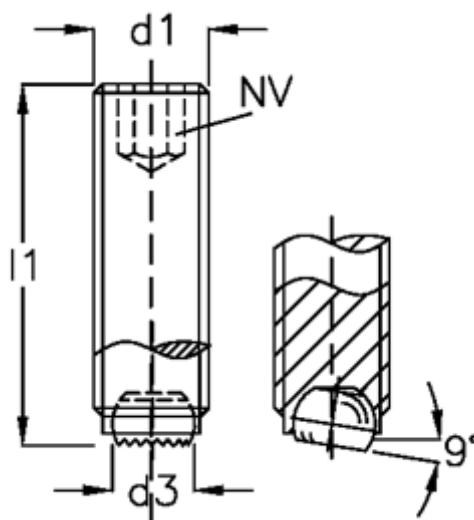

d1	= M8
d2	= 5.5
d3	= 4.5
Internal hexagon	= 4
l1	= 30